

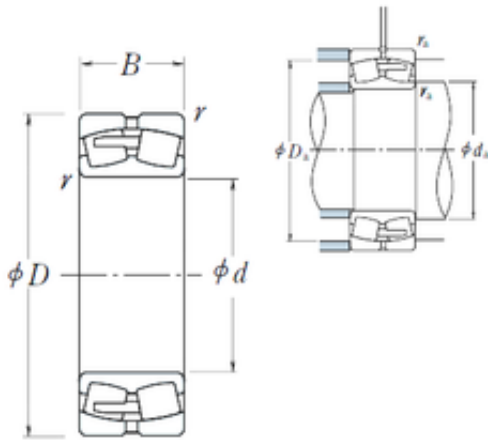

NSK 22244CAE4 spherical roller bearings



Bearing No. 22244CAE4

Size	220x400x108 mm
Bore Diameter	220 mm
Outer Diameter	400 mm
Width	108 mm
d	220 mm
D	400 mm
B	108 mm
C	108 mm
r min.	4 mm
da min.	238 mm
Da min	348 mm
Da max.	382 mm
ra max.	3 mm
Weight	59 Kg
Basic dynamic load rating (C)	1570 kN
Basic static load rating (C0)	2430 kN
(Grease) Lubrication Speed	850 r/min
(Oil) Lubrication Speed	1000 r/min
Calculation factor (e)	0,27
Calculation factor (Y0)	2,4
Calculation factor (Y2)	3,7

22244CAE4 Bearing 2D drawings and 3D CAD models